

W HEAPRO®



TATRA SAFETY®
YOUR TRUSTED SAFETY EQUIPMENT PARTNER

हिप्रो है जहाँ, सुरक्षा है वहाँ।

Pehle Suraksha
HEAPRO *First*



A mask in time saves
Quarantine

ABOUT US

Established in 1990 Continental Manufacturing Co. was set up to produce high precision components for automotive sector. After successfully working in the manufacturing segment it was observed that awareness of safety standards and use of right equipment was not satisfactory. Also high quality PPE's were not easily available.

Thus CMC gave birth to its baby 'HEAPRO' to make each life fear free from accident at workplace especially while working at height. With requisite experience in sheet metal & plastics HEAPRO PPE's were introduced to make each individual so confident that working at height becomes his passion.

HEAPRO is a name of prominence, reliability and trust in the market of personal protective equipments. For over a decade now HEAPRO is a leading brand manufacturing specialized equipments for every personnel working at higher altitudes.

With advanced architecture and buildings getting taller all HEAPRO equipments go through rigorous testing procedures while manufacturing so as to achieve ZERO DEFECT.

HEAPRO Safety equipments Manufacturing facilities are located at Rewari, Haryana. Head, face and Hearing protection equipments are manufactured at plastic moulding unit I located in sec-3 IMT Bawal. Fall Protection and other products are manufacture in unit II, located in sector 14 IMT Bawal.

Our team of experienced professionals is constantly innovating ideas for making safety equipments ideal and comfortable for use.

At HEAPRO we strive to provide you the best and will, continue to do so.



CMC is TS 16949:2009 certified company as it has a base to manufacture sub-assemblies for automobile O.E.M.'s. The safety products are manufactured by following the same system as for automotive and conforming to BIS norms. At HEAPRO all products go through rigorous testing stages to make sure that each equipment is strong and safe.

CERTIFICATIONS

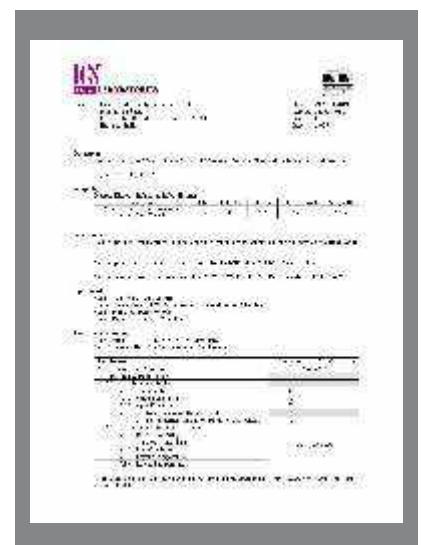
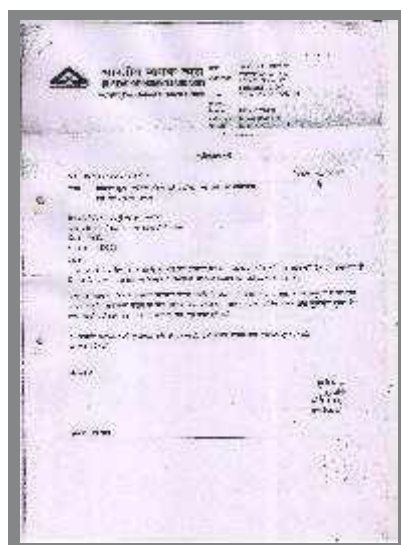
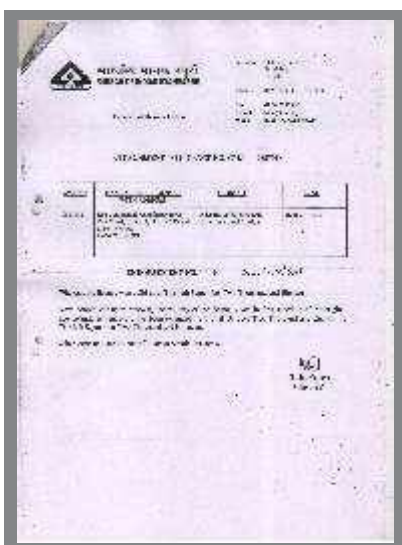
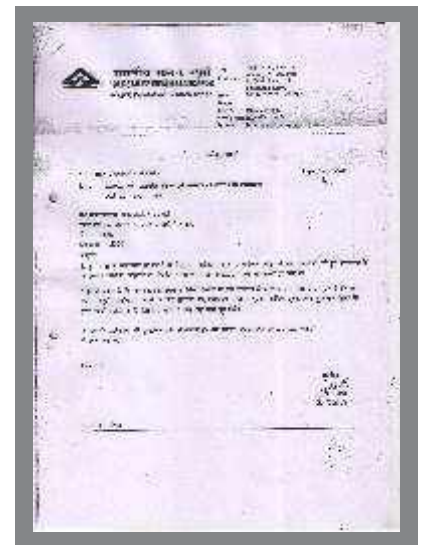
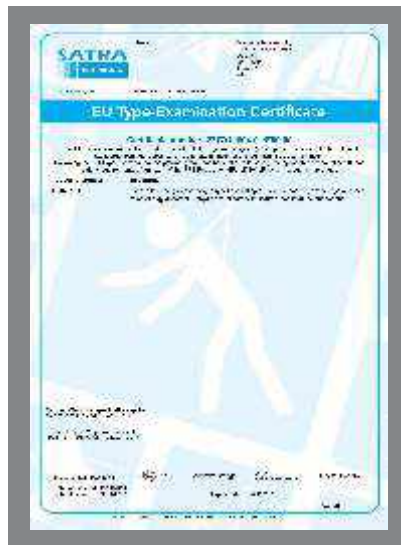

VENTRAVYZ CE

SAFETY HELMET

VENTED

LOUVERS FOR CROSS
VENTILATION

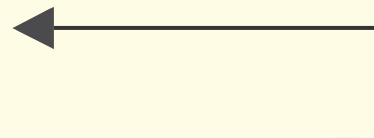

HEAPRO[®]

हिप्रो है जहाँ, सुरक्षा है वहाँ।

ELECELI CE /



SAFETY HELMET UNVENTED



SLOT AVAILABLE FOR
FIXING HELMET ACCESSORIES



WHEAPRO[®]

हिप्रो है जहाँ, सुरक्षा है वहाँ।

Made from special grade high density PE
 Light weight yet strong to ensure extended working hours
 Available in smart vented & unvented designs
 Louvers for cross ventilation in Heapro Ventra series
 Cushion pad for wearer's comfort
 Available in Pin Lock & Ratchet Design
 Skin Friendly Sweat Pad, Chin Strap & Cushion Pad
 Four point suspension
 Conforms to IS:2925-1984



HEAPRO VENTRA SERIES

Product Code	Model	Description
VLD-0011	VENTRA LD	Pin lock type plastic harness with HDPE shell
VR-0011	VENTRA LDR	Ratchet type plastic harness with HDPE shell
VY-0011	VENTRA LDY	Y strap type plastic harness with HDPE shell
VLD-0022	VENTRA LD 2H	Pin Lock type plastic harness with ABS shell
VR-0022	VENTRA LDR 2H	Ratchet type plastic harness with ABS shell

Colours Available :



You can customize with Your own text and/or Logo. Printing / stickering is Possible on the front and side of the helmet. Ask for our Favorable pricing.



HEAPRO STANDARD SERIES

Product Code	Model	Description
HSD-001	HEAPRO SD	Pin lock type plastic harness with HDPE shell
HR-001	HEAPRO SDR	Ratchet type plastic harness with HDPE shell
HY-001	HEAPRO SDY	Y strap type plastic harness with HDPE shell
HSD-002	HEAPRO SD 2H	Pin Lock type plastic harness with ABS shell
HR-002	HEAPRO SDR 2H	Ratchet type plastic harness with ABS shell

Colours Available :



The risk of head injury at work place is very common and should be taken care of in all circumstances. The use of safety helmets or hard hats prevents a worker from impact of a falling or flying object. Even a very small object falling from a height can cause a serious injury to a worker's head.

HEAPRO safety helmets are so designed as to protect and reduce the impact of any penetration or shock of a blow that may occur while in mining, construction, power and fabrication environments.

Although safety helmets provide limited safety against hazards at work place however if worn correctly, the right head gear ensures that most of the head injuries can be avoided or reduced thus protecting life of a worker.

Accessories like torch light, ear muffs and welding shields can also be used with manufacturer's guidelines.



Ratchet



Sweatband



Adjustable Quick Fit Pin Lock



Harness Comfort Cushion Pad

*The manufacturer holds the right to change the design of any model of helmets without any intimation based on continuous improvement activity for user's comfort and safety



HEAPRO ELECELI

SPECIFICATION : ELECELI		Product Code : ER - 01
1	MADE OUT OF SPECIAL GRADE ABS MATERIAL WITH NOVEL DESIGN.	
2	8 POINT TEXTILE SUSPENSION FOR COMFORT WEARING.	
3	LIGHT WEIGHT YET STRONG TO ENSURE COMFORT DURING EXTENDED WORKING HOURS.	
4	UNIVERSAL SLOTS ALLOW HEARING, WELDING AND VISOR ACCESSORIES TO BE ATTACHED EASILY.	
5	AVAILABLE IN UNVENTED MODEL AND SMART SINGLE PIECE RATCHET DESIGN	
6	SIZE RANGE BETWEEN 52 CMS - 63 CMS.	
7	TESTED FOR PROTECTION UPTO 20000 VOLTS	
8	SKIN FRIENDLY SWEAT PAD, CHIN STRAP AND CUSION PAD FOR EXTENDED WORKING COMFORT.	
9	CONFORMS TO THE STANDARD :-	
	ANSI / ISEA Z89.1 - 2014 TYPE I CLASS E, G & C. FOR ELECTRICAL INSULATION	
	EUROPEAN STD. EN 397 : 2012 + A1 : 2012 LD -30 DEG. C	
	EN 50365 : 2002 FOR ELECTRICAL INSULATION	

VENTRA VYZ

SPECIFICATION : VENTRA VYZ		Product Code : VR - 0122
1	MADE OUT OF SPECIAL GRADE ABS MATERIAL WITH NOVEL DESIGN.	
2	8 POINT TEXTILE SUSPENSION FOR COMFORT WEARING.	
3	LIGHT WEIGHT YET STRONG TO ENSURE COMFORT DURING EXTENDED WORKING HOURS.	
4	UNIVERSAL SLOTS ALLOW HEARING, WELDING AND VISOR ACCESSORIES TO BE ATTACHED EASILY.	
5	AVAILABLE IN VENTED MODEL AND SMART SINGLE PIECE RATCHET DESIGN	
6	SIZE RANGE BETWEEN 52 CMS - 64 CMS.	
7	Y STRAPED CHIN STRAP FOR COMFORTABLE FIT	
8	SKIN FRIENDLY SWEAT PAD, CHIN STRAP AND CUSION PAD FOR EXTENDED WORKING COMFORT.	
9	CONFORMS TO THE STANDARD :-	
	TYPE I, CLASS C	
	EUROPEAN STD. EN 397 : 2012 + A1 : 2012 LD -30 DEG. C	



Colours Available :



Colors can be customised for high volumes



Welding Face Shield
Product Code : WS-01

Welding Face Shield
Can be fixed with HEAPRO ELECELI
helmet with fixing bracket and adaptors



Fixing Bracket
Product Code : FB-01



Mounting Bracket
Product code : MB-01



Polycarbonate Visor
Product code : FS-01

Polycarbonate Visor (1mm thickness)
Aluminium framing on the edge
Can be fixed with HEAPRO ELECELI
helmet with fixing bracket and adaptors



Product code: HEAP 01

SPIRAL EAR PLUGS

NRR 23db as per ANSI S3 19-1974

SNR 28db as per CE EN 352-2

- Reusable for a long time in good shape
- Pure silicon material for low pressure inside the ear
- Humidity and sweat resistant
- 3 layer christmas tree design fits most ear canals comfortably

Technical Specification:

SNR: 33db

Material: Silicone

Hardness: 35°

Pulling Force: 5N

Rebound time: 45-60s

Cord Material/length: Polyester / 70 cm

Packed in individual poly bag

EAR PLUGS

NRR 32DB AS Per ANSI S3 19-1974 (Noise Reduction Rate)

SNR 34DB as per CE EN 352-2 (Signal to Noise Ratio)

PU Foam Earplugs with polyester cord

Technical Specification:

SNR: 33db

Material: PU

Rebound time: 45-60s

Size: 13*24mm

Cord Material/length: Polyester / 70 cm

Packed in individual poly bag



Product code: HEAP 02

EAR MUFFS



Product Code : EM-01



Product Code : EM-02

- Unique Double Layer Headband and ear cups for extended comfort.
- Soft and hide sealing rings filled with unique combination offer optimum sealing and low pressure.
- Exclusive design of cups help the ears to air out for improved comfort
- Suitable to use near loud machinery, Engines, Power tools & Loud Noise.

NRR 23db ANSI S3 19-1974

SNR 29db CE EN 352-1 : 2002

SAFETY EYEWEAR



Product Code : HEP-01

One Piece clear PC lens Scratch Resistant
Impact Resistant Light Weight
Zero Power - Suitable for Long Working Duration
ANSI Z87.1 : 2015



Product Code : HEP-02

One Piece clear PC lens Scratch Resistant
Impact Resistant Adjustable Temples
Zero Power - Suitable for Long Working Duration



Product Code : HEP-03

One Piece lens 99.9% Protection from UVA & UVB rays
Clear Lens Scratch Resistant Vented Templates Zero Power -
Suitable for Long Working Duration



Product Code : HEP-04

One Piece PC lens 99.9% Protection from
UVA & UVB ray Scratch Resistant Fog Resistant
Impact Resistant Vented Templates Light Weight
Zero Power - Suitable for Long
Working Duration

SAFETY EYEWEAR



- IR -5 Single Piece lens made from special grade pc material.
- Frame made from high grade Nylon.
- Suitable for protection against optical radiation (welding filters)
- Suitable for protection against high speed particles - low energy impact.

Product Code : HEP-05
Conforms to - EN 166 : 2001



Product Code : HEP - 06

Chemical Splash Goggle

Goggles With transparent glasses, Zero power, well fitting, covered from all sides with elastic band/or adjustable holder. Good seal with the skin of the face. Flexible frame to easily fit all face contours without too much pressure. Covers the eyes and surrounding areas and accommodates for prescription glasses. Fog and scratch resistant. Adjustable band to secure firmly so as not to become loose during clinical activity. Indirect venting to reduce fogging. May be re-usable (provided appropriate arrangements for decontamination are in place) or disposable.

Quality compliant Conforms to the below standards, or equivalent:

- a. EU standard directive 86/686/EEC, EN 166/2002
- b. ANSI/SEA Z87.1-2010

3 Ply Mask

- Disposable Face Mask – 3 ply.
- Odourless Non-woven Fabric.
- Anti-Bacteria Treated Fabric.
- High Quality Melt Brown Filter.
- Skin Friendly ear loops.
- Universal Size.



Product Code : HIM-03



FFP1 Mask

Features:

- Protection against certain oil and Non-oil based particles
- Mask is provided with hidden aluminum adjustable nose clip and sponge nose pad ensuing custom shape and for worker comfort
- Mask is flat fold designed
- Ultrasonically welded strap to avoid open layer around the edges and provide high level of protection
- Mask is provided with double elastic fabric strap
- Effective Protection: Filtration efficiency against non-oil based particles is more than 95%.

Product Code : M100



Coverall

Product Code : MCO-01

- Personal Protective Coverall (Garments) with Tape over Seam - recommended for Single use
- The Fabric as per ASTM F1670.
- Designed to be universal Fit
- In built Hood Cap
- Zipper of the coverall covered with a flap to avoid accumulation of microbes
- Soft Elastic fitted around Front of hood, wrists & ankles.

Shoe Cover PP

Product Code : MSC-01

- Made of same fabric as coverall
- Length approx. 2-3 inches below knee
- Soft elastic at ankle and opening end of the shoe cover



Chemical Splash Goggle

Product Code : HEP - 06



Goggles With transparent glasses, Zero power, well fitting, covered from all sides with elastic band/or adjustable holder. Good seal with the skin of the face. Flexible frame to easily fit all face contours without too much pressure. Covers the eyes and surrounding areas and accommodates for prescription glasses. Fog and scratch resistant. Adjustable band to secure firmly so as not to become loose during clinical activity. Indirect venting to reduce fogging. May be re-usable (provided appropriate arrangements for decontamination are in place) or disposable. Quality compliant Conforms to the below standards, or equivalent:

- EU standard directive 86/686/EEC, EN 166/2002
- ANSI/SEA Z87.1-2010

3 Ply Mask

Product Code : HIM-03

- Disposable Face Mask – 3 ply.
- Anti-Bacteria Treated Fabric.
- Skin Friendly ear loops.
- Odourless Non-woven Fabric.
- High Quality Melt Brown Filter.
- Universal Size.



Nitrile examination gloves

Product Code : NITROSOL N15

- Disposable Surgical Hand Gloves

CARE AND USES OF HARNESS

A fall arrest system is required if any risk exists that a worker may fall from an elevated position. As a general rule, the fall arrest system should be used anytime a working height of six feet or more is reached. Working height is the distance from the walking/working surface to a grade or lower level. A fall arrest system will only come into service should a fall occur. A full-body harness with a shock-absorbing lanyard are preferably recommended. A full-body harness distributes the forces throughout the body, and the shock-absorbing lanyard decreases the total fall arresting forces.

Inspection of Harness and Lanyard before use

1. Check that the fall indicator is not damaged. Damaged fall indicator indicates that the harness has been subjected to accident. Thus harness is unfit for use.
2. Webbing should be free from natural wear & tear, cut or loose fibres.
3. There should be no cut in stitching or broken thread coming out at any point.
4. All metal parts should be free from rust, crack, deformation or damage.
5. Inspect the rope for any visual damage, wear & tear. The rope is not fit for use if the colour fibre life indicator has faded.



How to Wear a Harness



Step 1
Hold harness by back D-ring, Shake harness to allow all straps to fall in place



Step 2
If chest, leg and/or waist straps are buckled, release straps and unbuckle at this time.



Step 3
Slip straps over shoulders. so D-ring is located in middle of back between shoulder blades.



Step 4
Pull leg straps between legs and connect to opposite end. Repeat with second leg strap. If belted harness, connect waist strap after leg straps



Step 5
Connect chest strap and position in mid chest area. Tighten to keep shoulder straps taut



Step 6
After all straps have been buckled, tighten all buckles so that harness fits snug but allows full range of movement, Pass excess strap through loop keepers



SAFETY HARNESS

A fall from height can be fatal without the use of right protective gear and training on how to use it. With buildings getting taller and using advanced architecture, the risk of falling has also increased manifold.

HEAPRO harnesses are manufactured on automatic machines using dope dyed high strength German yarn for reliable stitching



CLASS-A (For basic Fall Arrest)

Product Code : HI-32

- ISI Mark : Conforms to ISI 3521:1999
- Special Grade forged steel used for high tensile strength
- Polyester webbing with high breaking strength
- Zinc plated metal parts

Attachment Elements: A Dorsal attachment D-Ring for Fall Arrest

Adaptability: Adjustable Chest-Strap & Thigh-Straps

CLASS-D (For Controlled Descent)

Product Code : HI-28

- ISI Mark : Conforms to ISI 3521:1999
- Special Grade forged steel used for high tensile strength
- Polyester webbing with high breaking strength
- Zinc plated metal parts

Attachment Elements: Sternal D-Ring at the front is use in the event of controlled decent from height. A Dorsal Attachment D-Ring for Fall Arrest.

Adaptability: Adjustable Thigh-Straps.



CLASS -E (For Entry & Exit in Confined)

Product Code : HI-38

- ISI Mark : Conforms to ISI 3521:1999
- Special Grade forged steel used for high tensile strength
- Polyester webbing with high breaking strength
- Zinc plated metal parts

Attachment Elements: Two Sliding D-Rings one on each shoulder strap, this helps into confined spaces. A dorsal attachment D-Ring for Fall Arrest.

Adaptability: Adjustable Chest-Strap & Thigh-Straps.

CLASS -P (For Work Positioning)

Product Code : HI-34

- ISI Mark : Conforms to ISI 3521:1999
- Special Grade forged steel used for high tensile strength
- Polyester webbing with high breaking strength
- Zinc plated metal parts

Attachment Elements: A Dorsal Attachment D-Ring helps in positioning the worker so that he can work with both hands free.

Adaptability: Adjustable Chest-Strap & Thigh-Straps.

CLASS -L (For Ladder & Tower Climbing)

Product Code : HI-36

(CE - 2777)

- ISI Mark: Conforms to ISI 3521:1999
- Special Grade forged steel used for high tensile strength
- Polyester webbing with high breaking strength
- Zinc plated metal parts

Attachment Elements: 2 chest attachment D-Ring for tower climbing. A Dorsal Attachment D-Ring for Fall Arrest.

Adaptability: Adjustable Chest-Strap, Shoulder Strap &

LOOP COMBINATIONS

Description	Image	Code	Image	Code	Image	Code	Image	Code
Twisted Rope Lanyard		HI 402		HI 404		HI 408		HI 412
Kernmantle Rope Lanyard		HI 562		HI 564		HI 568		HI 572
Webbing Lanyard		HI 442		HI 444		HI 448		HI 452
Energy Absorbing Twisted Rope Lanyards		HI 602		HI 604		HI 608		HI 612

KARABINER COMBINATIONS

Description	Image	Code	Image	Code	Image	Code
Twisted Rope Lanyard		HI 406		HI 414		HI 416
Kernmantle Rope Lanyard		HI 566		HI 574		HI 576
Webbing Lanyard		HI 446		HI 454		HI 456
Energy Absorbing Twisted Rope Lanyards		HI 606		HI 614		HI 616

SNAP HOOK COMBINATIONS

Description	Image	Code	Image	Code
Twisted Rope Lanyard		HI 410		HI 418
Kernmantle Rope Lanyard		HI 570		HI 458
Webbing Lanyard		HI 450		HI 578
Energy Absorbing Twisted Rope Lanyards		HI 610		HI 618



Work Positioning Lanyard with Ring Type Adjuster

Product code: HI 482

- Made up of 14 mm dia polyamide 3-strand twisted rope.
- Max. Length 2.0 meter.
- Manual Ring Type adjuster of forged alloy steel.
- Easy to connect Steel Karabiner at both the ends for attachment.
- Also available with a 300 mm long protective covering sleeve.



Work Positioning Lanyard with Grip Adjuster

Product code: HI 490

- Made up of Kernmantle rope of dia 10.5 mm
- Max. Length 2.0 meter.
- Rope grab adjuster for easy length adjustment.
- Easy to connect Steel Karabiners at both the ends for attachment.
- Also available with a 300 mm long protective covering sleeve.



Work Positioning Lanyard with Ring Adjuster

Product code: HI 488

- Made up of Kernmantle rope of dia 10.5 mm
- Max. Length 2.0 meter.
- tope grab adjuster for easy length adjustment.
- Easy to connect Steel Karabiner at both the ends for attachment.
- Also available with a 300 mm long protective covering sleeve.



Work Positioning Lanyard with Grip Adjuster | Product code: HI 484 (CE - 2777)

- Made up of 14 mm dia polyamide 3-strand twisted rope.
- Max. Length 2.0 meter.
- Equipped with convenient rope grab adjuster for easy length adjustment.
- Easy to connect Steel Karabiner at both the ends for attachment.
- Also available with a 300 mm long protective covering sleeve.



Webbing Work Positioning Lanyard with Ring Adjuster | Product code: HI 486

- Made up of 33 mm wide polyester webbing.
- Max. Length 2.0 meter.
- Manual Ring type adjuster of forged alloy steel.
- Easy to connect Steel Karabiner at both the ends for attachment.
- Also available with a 300 mm long protective covering sleeve.



FORKED LANYARDS



(CE - 2777)

Product Code	Image	Description	Length
HI 682-KE		Energy Absorbing forked Kernmantle Rope Lanyard with Karabiner Hook Connector at Harness end and 2 nos of Scaffold Hooks at Anchorage end.	2 Meter
HI 682-SE		Energy Absorbing forked Kernmantle Rope Lanyard with Snap Hook Connector at Harness end and 2 nos of Scaffold Hooks at Anchorage end.	2 Meter
HI 682-KS		Energy Absorbing forked Kernmantle Rope Lanyard with Snap Hook Connector at Harness end and 2 nos of Snap Hooks at Anchorage end.	2 Meter
HI 702-KR-SE-D		Kernmantle Rope forked lanyard with Snap hook Connector at Harness end and 2 Nos of Scaffold hooks at Anchorage end.	2 Meter

Product Code	Image	Description	Length
HI 702-KE		Energy Absorbing forked Polyamide Rope Lanyard with Karabiner Hook Connector at Harness end and 2 nos of Scaffold Hooks at Anchorage end.	2 Meter
HI 702-SE		Energy Absorbing forked Polyamide Rope Lanyard with Snap Hook Connector at Harness end and 2 nos of Scaffold Hooks at Anchorage end.	2 Meter
HI 704		Energy Absorbing forked Polyamide Rope Lanyard with Snap Hook Connector at Harness end and 2 nos of Snap Hooks at Anchorage end.	2 Meter

Product Code	Sketch	Description	Length
HI 722		Energy Absorbing forked Polyester Webbing Lanyard with Karabiner Hook Connector at Harness end and 2 nos of Scaffold Hooks at Anchorage end.	2 Meter
HI 722-SE		Energy Absorbing forked Polyamide Rope Lanyard with Snap Hook Connector at Harness end and 2 nos of Scaffold Hooks at Anchorage end.	2 Meter





CONNECTORS

HEAPRO Connectors are made up of high tensile steel, Tested for corrosion resistance for Min. 72 Hrs of Salt Spray test.



SCAFFOLDING HOOK

Product Code : HI-262E

Conforms to EN-362

Material: Forged Alloy Steel

Opening : 55 mm | Strength : > 20 kN



KARABINER HOOK

Product Code : HI-224K

Conforms to EN-362

Material : Alloy Steel

Opening : 15 mm | Strength : > 20 kN



SNAP HOOK

Product Code : HI-242

Conforms to EN-362

Material : Alloy Steel

Opening : 18 mm | Strength : > 20 kN



TURN LOCK KARABINER

Code : HI - LK - 01

- Twist Lock / Self Locking
- Conforms to : EN 362:2004 Class B,
- Material :- High Tensile Steel,
- Surface Finish : Zinc coated yellow passivation,
- Gate opening : 24 mm
- Breaking Strength : 50 KN.
- Net Weight : 267 gms

HEAPRO Fall Arrester move easily up and down vertical lifelines to provide continuous fall protection. Trailing models offer complete hands-free operation for increased productivity. In the event of a fall, HEAPRO Fall Arrester locks quickly.

- Compact design; corrosion-resistant stainless steel construction
- Lightweight and easy to use



OPENABLE TYPE FALL ARRESTER

Heapro Openable type Fall Arrester made up of High Tensile Strength steel & works on 14 to 16 mm dia Polyamide Rope

Conforms to EN-353-2

Product Code : HFA01



NON-OPENABLE TYPE FALL ARRESTER

Non Openable type fall arrester works on 12mm kernmantle rope. It is generally used on platforms & roofs to prevent a worker from falling in the event of slipping.

Conforms to EN-353-2

Product Code : HRG 01

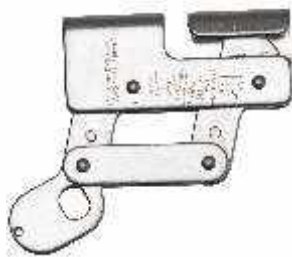

WIRE ROPE GRAB

Heapro Wire Rope Grab made up of High Strength Stainless steel & works on 8 mm dia of Steel Wire.

Conforms to EN-353-1

Product Code : HRG02



HEAPRO ENERGY ABSORBER

Heapro Energy absorber is made up of 44 mm wide webbing & shrink wrapped. It reduces the impact of fall to less than 6kN.

The minimum fall clearance distance required for using Heapro energy absorber for 2 meter lanyard is 6m.

Conforms to EN-355

Product code : HEA01



HORIZONTAL LIFE LINE

Temporary Horizontal Life Line

- Product Name: Temporary Horizontal Life line
- Product Code: HLL – 20M
- Used for assembly work in Sheet works, Scaffolding & Construction work
- Available in 30 mm. (Width) heavy duty Polyester Webbing.
- Webbing Strength: Min. 25 KN
- Provided with Ratchet type tensioner
- Available in 20 Mtr. Length.
- Suitable for use of two person at the same time
- Supplied with protective carry bag
- Conforms to: EN 795:2012, Class C.



Temporary Horizontal Lifeline can be installed between two suitable anchor points, the user can fix the lanyard on the lifeline and work freely upto 20 mtrs.

Important: Consider the deflection the HLL at the time of installation in addition to the Clearance of fall arrest system used. Generally it should not be less than 10% of the span in which the HLL is used.

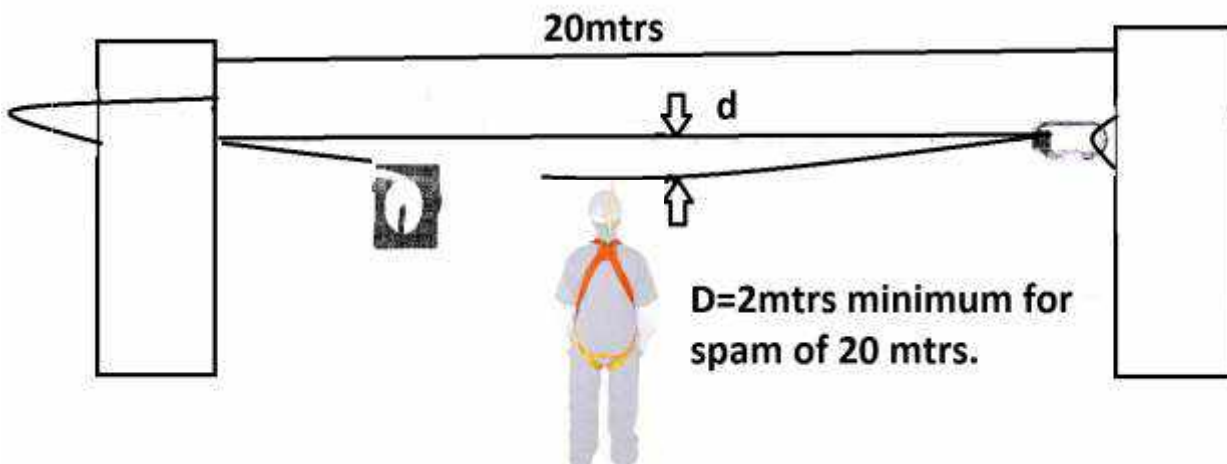

RETRACTABLE FALL ARRESTERS



Heapro Retractable Fall Arresters

HEAPRO RETRACTABLE FALL ARRESTERS are useful at site locations where free fall clearance distance is not enough. In case of free fall, the Retractable Blocks reduce the fall to minimum reducing the impact force on the user. The user can anchor the Retractable Block and work freely upto a distance based on size of the block.

1- Part Name:- Self Retracting Lifeline.

Products Code	Type	Weight
HI-9000-6M	Class A	3.0 Kgs
HI-9000-10M	Class B	4.5Kgs
HI-9000-12M	Class B	5.8 Kgs
HI-9000-15M	Class B	6.5Kgs
HI-9000-20M	Class B	7.7Kgs

- 3- Conforms to: EN 360 : 2002.
- 4- Available in polymer casing with high impact strength material.
- 5- Available with Steel wire rope with dia. 5.0mm.
- 6- Available with Swivel type Snap hook.
- 7- Available in length 6Mtr, 12Mtr & 15Mtr.





PARAPET ANCHOR



Step 1



Step 2



Step 3

SAFE ANCHORAGE SOLUTION FOR PARAPET WALLS AND FACADES

HEAPRO Parapet Anchor is the best solution for Parapet walls and Façade where no fixed anchor is provided.

HEAPRO Parapet Anchor has a maximum opening of 365 mm and can be easily installed on robust parapet walls to work on facades. This portable device is very useful in façade finishing

- Made from High Strength Steel.
- Powder Coated for Corrosion Protection
- Minimum Breaking Strength :- 23 KN
- Maximum Opening :- 365 mm
- Net Weight:- 9.4 kgs
- Conforms to :- EN 795 : 1996 Class B,



D-Bolt Anchor Specification

1. D-shaped forged steel anchor
2. Material - Alloy steel
3. Minimum breaking strength - 23kn
4. Conforms to - EN 795:2012



Tool Bag
Qty : 01
Code : HTB-01



Multipurpose Harness
Qty : 01
Code : HI-112



HeaproMan's Kit Bag
Qty : 01
Code : HKB-01



Anchorage Rope HI 1900
Qty : 01
Code : HI-1900 (14mm) (50 mtr.)



Webbing Sling
Qty : 02
Code : HI-1606



Fall Arrester
Qty : 01
Code : HFA-01



Kernmantle Rope
Qty : 01
Code : HI-1900K (50 mtr.)



Karabiner
Qty : 03
Code : HI-224



Heapro Swing Seat
Qty : 01
Code : HSS-01



Descender
Qty : 01
Code : DS-01





Rope Ladder:

- Available in special type wood material with ultra finish & smoothness.
- High strength PP rope used in dia. 12 mm.
- Light weight, smooth finish for user safety & comfort.
- Available in two lengths 3 Mtr. & 5 Mtr.
- Available with Carabineer hook for easy anchoring

Rope Protector

Useful to protect the rope at sharp edges can be used with 10 to 16mm ropes - kernamantle and polyamide



Roller Pulley

Code: HI-PU-01

- Made from special grade Stainless Steel material with high strength & ultra-light weight.
- Compatible to work with "Heapro Duro Rock Chair" for user comfort.
- Suitable to work up to 50 mm dia. Wire rope.
- Strength: Min. 15 KN.
- Conforms to: EN 12278:2007.
- Product image shown may be different from

TOWER KIT



Multipurpose Harness
Qty : 01
Code : HI-112



Fall Arrester
Qty : 01
Code : HFA-01



Tool Bag
Qty : 01
Code : HTB-01



Work Positioning
Qty : 01
Code : Lanyard HI-484



Anchorage Rope HI 1900
Qty : 01
Code : HI-1900 (14mm) (50 mtr.)



Forked Lanyard
Qty : 01
Code : HI-702 PA-SE-D



HeaproMan's Kit Bag
Qty : 01
Code : HKB-01



Tower/Rebar Hook

Code : HI - ATH

- Double Action / Self Locking
- Conforms to :- EN 362 : 2004 Class B,
- Material :- Aluminum Alloy,
- Standard Finish :- Self Colored
- Gate Opening :- 110 mm.,
- Minimum Breaking Strength :- 23 KN,
- Net Weight :- 925 gms

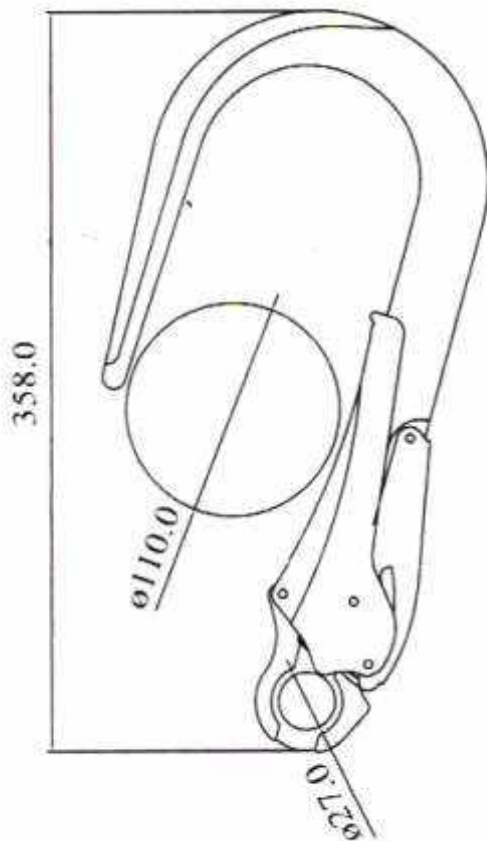

HEAPRO TOWER HOOK

ATH-110 is suitable for anchoring at channels of width less than 110mm. Manufactured from special aluminium alloy, it is light weight and easy to use.

TOWER HOOKS

Tower Hooks

Code : 85

- Double Action / Self Locking
- Conforms to :- EN 362 : 2004 Class B
- Material :- High tensile steel
- Standard Finish :- Self Colored
- Gate Opening :- 85mm
- Minimum Breaking Strength :- 23 KN
- Net Weight :- 860 gms

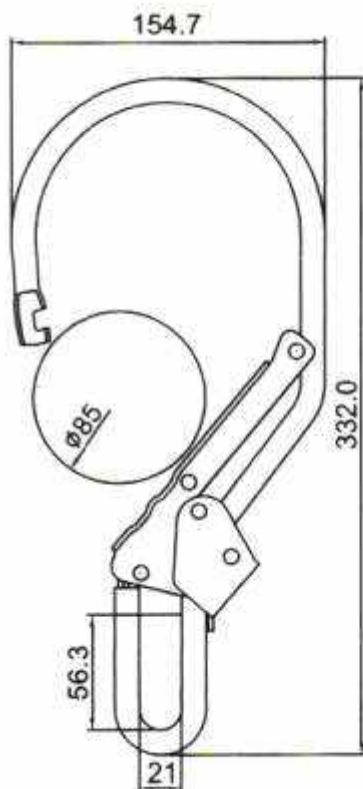

HEAPRO TOWER HOOK STH-85

is suitable for anchors of less than 85mm diameter.

Manufactured from high tensile steel, it is designed for light weight and easy to use.

MULTIPURPOSE HARNESS CE



Product Code HI-112

HEAPRO manufactures high quality safety harnesses for use in different applications. HEAPRO multipurpose harness is suitable in most situations like tower climbing, facade painting and window maintenance, rescue operations etc.

Multipurpose harness has following salient feature:

- Fully adjustable with rope access
- Comfort pad at shoulder waist and thigh enhances efficiency of a worker during long working hours.
- Suitable for work positioning, fall arrest and work restraint situations.



Code: HI-112A (CE - 2777)

- Made from high strength Polyester / Nylon webbing
- Fully Adjustable means provided
- Comfort pad at shoulder waist & thigh enhances efficiency of worker during long working hours.
- Used for tower climbing, facade painting, window maintenance & rescue operations.
- Suitable for work positioning, fall arrest & work restraint situations
- Conforms to: EN 361:2002, EN 358:1999 & EN 813:2008.

CE



HEAPRO RESCUE KIT

PRODUCT CODE : HRK01



Multipurpose Harness
Qty : 01
Code : HI-112

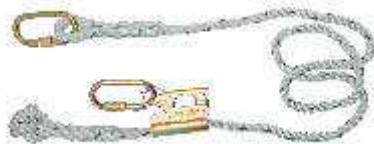

Work Positioning
Qty : 01
Code : Lanyard HI-484



Webbing Sling
Qty : 02
Code : HI-1606



Cows Tail
Qty : 01
Code : HI-802



Fall Arrester
Qty : 01
Code : HFA-01



Karabiner
Qty : 03
Code : HI-224



Anchorage Rope
Qty : 01
Code : HI-1900 (14mm) (50 mtr.)



Petzl ID
Qty : 01
*Optional



Forked Lanyard
Qty : 01
Code : HI-682 KE



Kernmantle Rope
Qty : 01
Code : HI-1900K (50 mtr.)



HeaproMan's Kit Bag
Qty : 01
Code : HKB-01



HEAPRO LITE (HI - EX - 301)

TYPE	: DERBY, 4 EYELETS
UPPER	: FULL GRAIN LEATHER WITH PADDED COLLAR
OUTSOLE	: PU DIRECTLY MOULDED SOLE.
LINING	: PADDED SYNTHETIC
TOE	: STEEL TOE 200 JOULE



SHOES DERBY ▶▶

Code : HI - EX - 501

UPPER LEATHER	BUFF SPLIT BARTON 1.8-2.0MM
EYELET 'U' PART	SPLIT BARTON THICK NESS 1.1-1.3MM
TONGUE	PU COAGULATED
LINING	DISTANCE MESH GREY
VAMP LINING	NONWOVEN
INSOLE	200 J
METAL FITTING	EYE LET
SOCKS	FABTEX WITH EVA CUSHIONING
SOLE	SINGLE DENSITY-522



◀◀ SHOES ANKLE

Code: HI - AK - 502

- Full Grain fine leather Thickness: 1.8 - 2.00 mm.
- Breathable, highly flexible, extra strong for comfort and long wear ability.
- Molded PU sole with deep cleats.
- High density light weight, slip resistant, resistant to certain types of oils / chemicals, can withstand temp. Of 100 deg C for 1 minute. Highly flexible and low abrasion for extra life.
- TOE CAP: Made with Alloy Steel. Light weight / Rust free with an ability to withstand an impact of 200 J as per IS - 15298.
- THREADS: 3 Ply / 6 Ply nylon. To make the uppers strong at all the joints and intern enhances the looks and life.
- REFERENCE STANDARD: - Conforms to IS 15298.



DOUBLE DENSITY (HI - EX - 701)

TYPE	:	DERBY, 4 EYELETS
UPPER	:	BUFF PRINTED LEATHER
OUTSOLE	:	PU DIRECT INJECTION SOLE, DOUBLE DENSITY
LINING	:	PADDED SYNTHETIC
TOE	:	STEEL TOE 200 JOULE





Product Code : HI-901 (Derby)

- 1- Fine quality upper leather of 1.8-2.0 mm thickness
- 2- Breathable, highly flexible, extra strong for comfort and long wear ability.
- 3- Direct injected PU sole,
- 4- High density light weight, slip resistant, resistant to certain types of oils / chemicals, can withstand temp. Of 100 deg C for 1 minute. Highly flexible and low abrasion for extra life.
- 5- TOE CAP: Made with Alloy Steel. Light weight / Rust free with an ability to withstand an impact of 200 J as per IS - 15298.
- 6- THREADS: 3 Ply / 6 Ply nylon. To make the uppers strong at all the joints and intern enhances the looks and life.

Colours Available:



Product Code : HI-901 C (Derby Composite Toe)

- Fine quality upper leather of 1.8-2.0 mm thickness
- Non-woven 270 GSM Vamp Lining
- Synthetic Leather with 6mm PU Foam Tongue
- Synthetic Leather with 14mm PU Foam Collar
- Thermoplastic – thickness 2mm Counter Stiffener
- Nylon 6/3 ply Thread
- Non-woven Insole
- Plastic Eyelet
- Wide fitting Composite with 200 J impact resistance & 15 KN Compression resistance Toe Cap Oil/Chemical Resistant
- Direct injected PU sole
- Up to 140 °C for 1 minute Heat Resistant
- Up to 15 KVA Electrical Resistance
- Textile laminated molded EVA In Socks
- UK 05 to 12, EU 39 to 46 Sizes
- IS 15298 (Part II):2016 & EN ISO 20345:2011





Product Code : HI-902 (Ankle Double Density)

- 1- Fine quality upper leather of 1.8-2.0 mm thickness
- 2- Breathable, highly flexible, extra strong for comfort and long wear ability.
- 3- Direct injected PU sole, Double Density
- 4- High density light weight, slip resistant, resistant to certain types of oils / chemicals, can withstand temp. Of 100 deg C for 1 minute. Highly flexible and low abrasion for extra life.
- 5- TOE CAP: Made with Alloy Steel. Light weight / Rust free with an ability to withstand an impact of 200 J as per IS - 15298.
- 6- THREADS: 3 Ply / 6 Ply nylon. To make the uppers strong at all the joints and intern enhances the looks and life.

Colours Available:



Product Code : M 1000 (Executive Shoes)

- 1- Executive style Design, Suitable for Senior Staff
- 2- Fine quality upper leather of 1.8-2.0 mm thickness
- 3- Breathable, highly flexible, extra strong for comfort and long wear ability.
- 4- Direct injected PU sole,
- 5- High density light weight, slip resistant, resistant to certain types of oils / chemicals, can withstand temp. Of 100 deg C for 1 minute. Highly flexible and low abrasion for extra life.
- 6- TOE CAP: Made with Alloy Steel. Light weight / Rust free with an ability to withstand an impact of 200 J as per IS - 15298.
- 7- THREADS: 3 Ply / 6 Ply nylon. To make the uppers strong at all the joints and intern enhances the looks and life.





GUMBOOT

Code : HI - ATH

- MATERIAL: - Made with Full PVC. Water Repellent, highly flexible, extra strong for comfort and long wear ability.
- Available in knee Length with extra protection and comfort.
- 3-SOLE: - Made in molded PVC. High density light weight, slip resistant, resistant to certain types of oils / chemicals, can withstand temp. Of 100 deg C for 1 minute. Highly flexible and low abrasion for extra life.
- TOE CAP: - Made with Alloy steel. Light weight / Rust free with an ability to withstand an impact as per IS - 12254.

S3 Leather Shoes

HI-S3 (S3 Leather Shoes)

1. S3 Superior Upper Leather of 1.8-2.0 mm thickness
2. Durable for consistent use on metal decks (ships / petrochemical rigs)
3. Anti Slip Heels
4. Oil / Fuel, Grease and Weak acids / alkali resistant Outsole
5. Injected Double Density PU outsole
6. Carbon Composite Toe Cap (to Withstand impact of 200 Joules)
7. Padded Collar, Low Ankle
8. Water Proof Leather upper
9. Woven Penetration Resistant Insole Layer (Kevlar Soles)
10. Anti-Fungal Flexible insole, Dry Lining with Anti-static carbon thread stitched
11. Hi-visibility tapes on sides (optional)
12. Energy Absorbing Heels
13. Heat Resistant 120c for 1 minutes





REFLECTIVE WORKWEAR

Get your Reflective Workwear customized from HEAPRO



Code : H00 - 001

- Made with standard comfort fabric.
- Size Available: - S, M, L, XL and XXL.
- Available with full sleeve and extra pockets.